

PS 22.3

Sistema scorrevole ad una via di corsa per ante e binari a ridosso
One-way sliding system for rails and door frontally applied

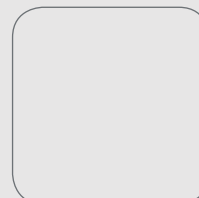

features

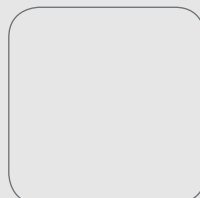
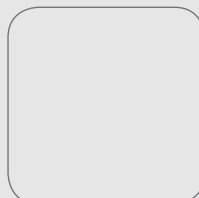
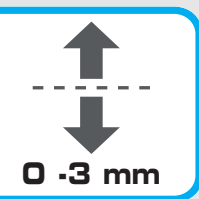
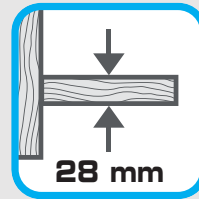
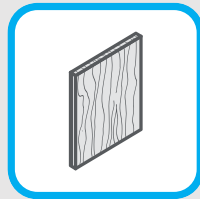

1

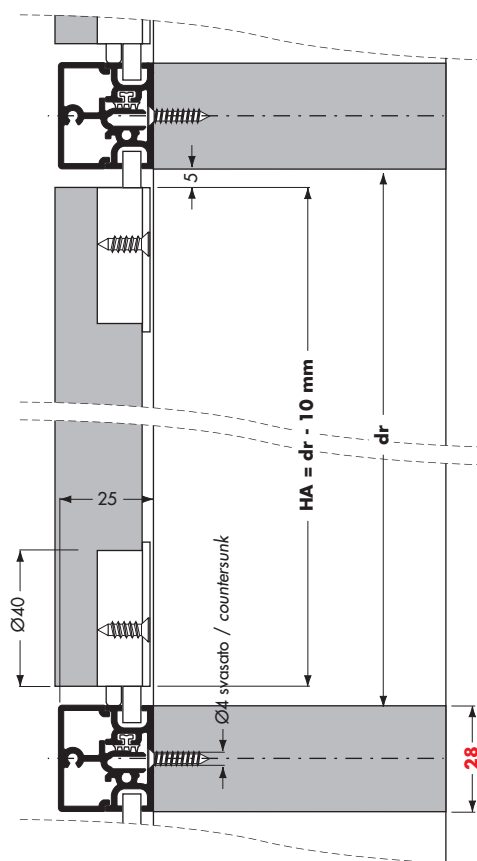

2

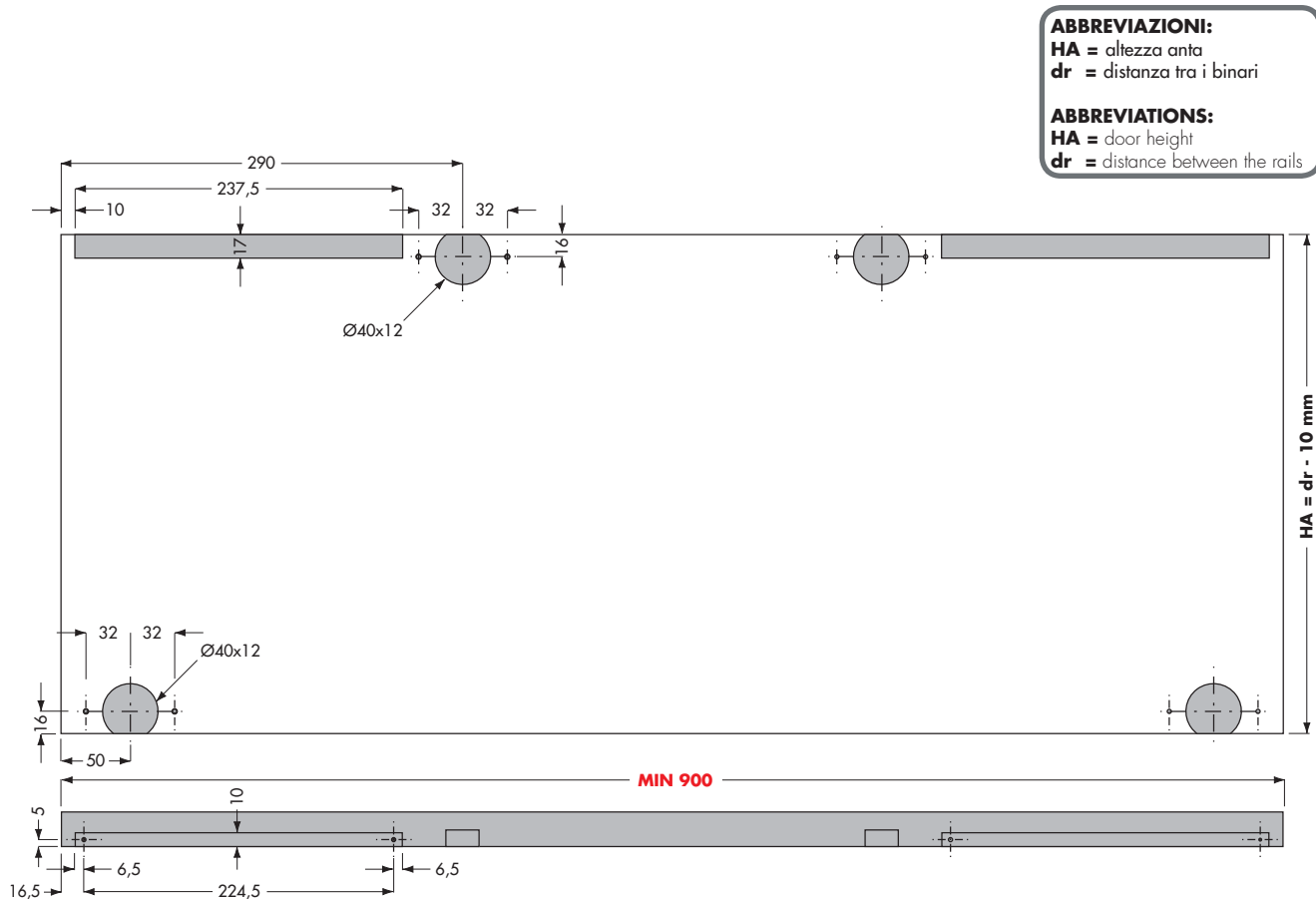

PS22.3 | Lista componenti - Parts list

PR227000031A **H 22**

PR227000033A **H 25**

PR227000015A **H 28**

PR227000009A **H 30**

PR227000006A **H 35**

Binario superiore - inferiore per ripiano.
Finiture: vedi pag 7

Upper - lower rail for shelf.
Finishes: see page 7

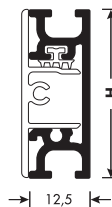

H = 22 mm
H = 25 mm
H = 28 mm
H = 30 mm
H = 35 mm

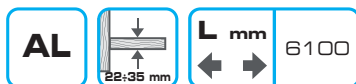
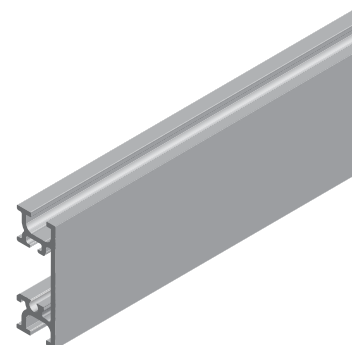

PR227000027A

Profilo copertura.
Finiture: vedi pag 7

Cover profile.
Finishes: see page 7

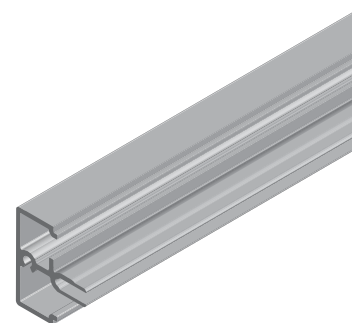
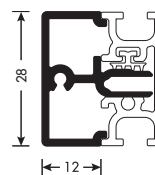

PR22820001

Guarnizione per fissaggio copertura su binario.
Finitura: Neutra

Gasket for cover fixing in the rail.
Finish: Neutral

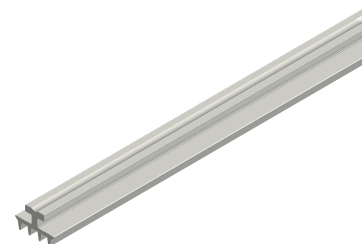
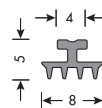

PS22SA8B01

Distanziatore di sicurezza.
Finitura: Grigio

Safety spacer.
Finish: Grey

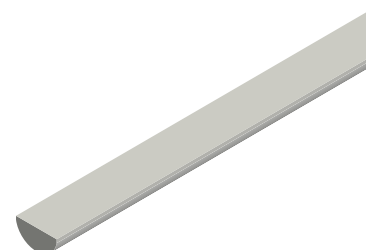
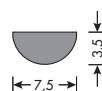

PS22KT70020008

Confezione tappi di testa per binario.
 Finitura: Anodizzato argento chimico

Kit of head plugs for rail.
 Finish: Chemical silver anodized

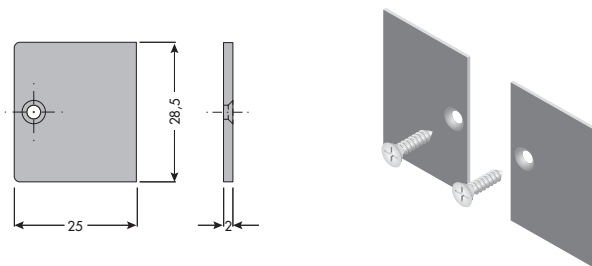

PS22KP8B04

Confezione pattini.
 Finitura: Grigio

Kit of slides.
 Finish: Grey



PS22KD402E04





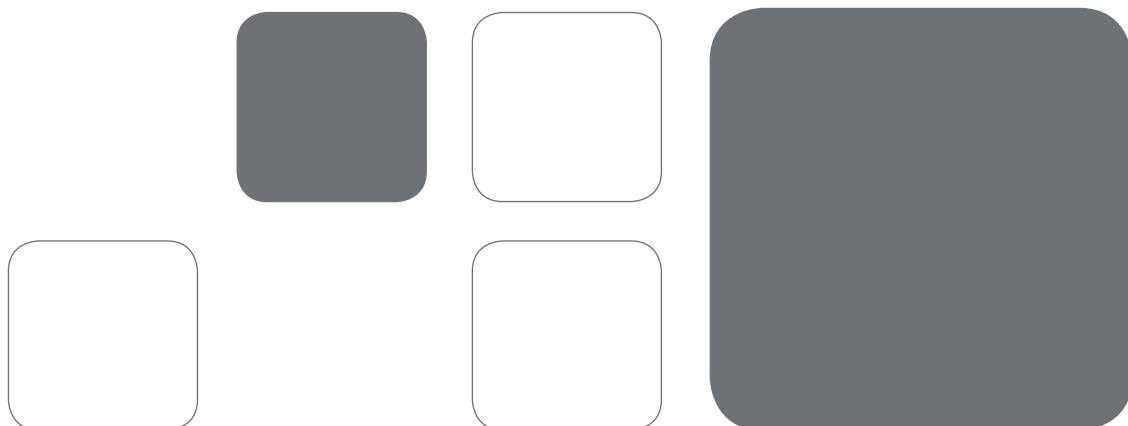
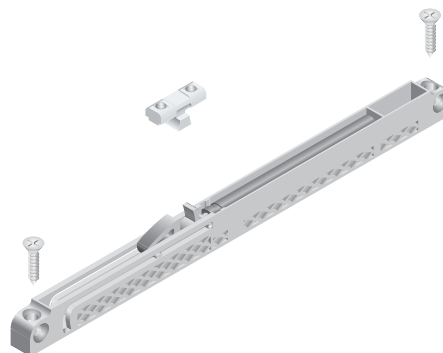





Confezione ammortizzatore.
 Finitura: Grigio

Kit of soft-closing device.
 Finish: Grey



Icone

Icons

	Portata Load capacity		Sistema di ammortizzazione "soft-closing" Soft-closing device
	Peso anta Door weight		Certificato Catas Catas Certificate
	Regolazione verticale Vertical adjustment		Reversibile Reversible
	Per ante in legno For wooden doors		Lunghezza binario/profilo Rail/profile length
	Spessore ripiano in legno Wooden shelf thickness		Alluminio Aluminium
	Ante in legno Wooden doors		Plastica Plastic
	Lavorazioni necessarie Need of some metal or wood processing		Istruzioni montaggio Assembly instructions

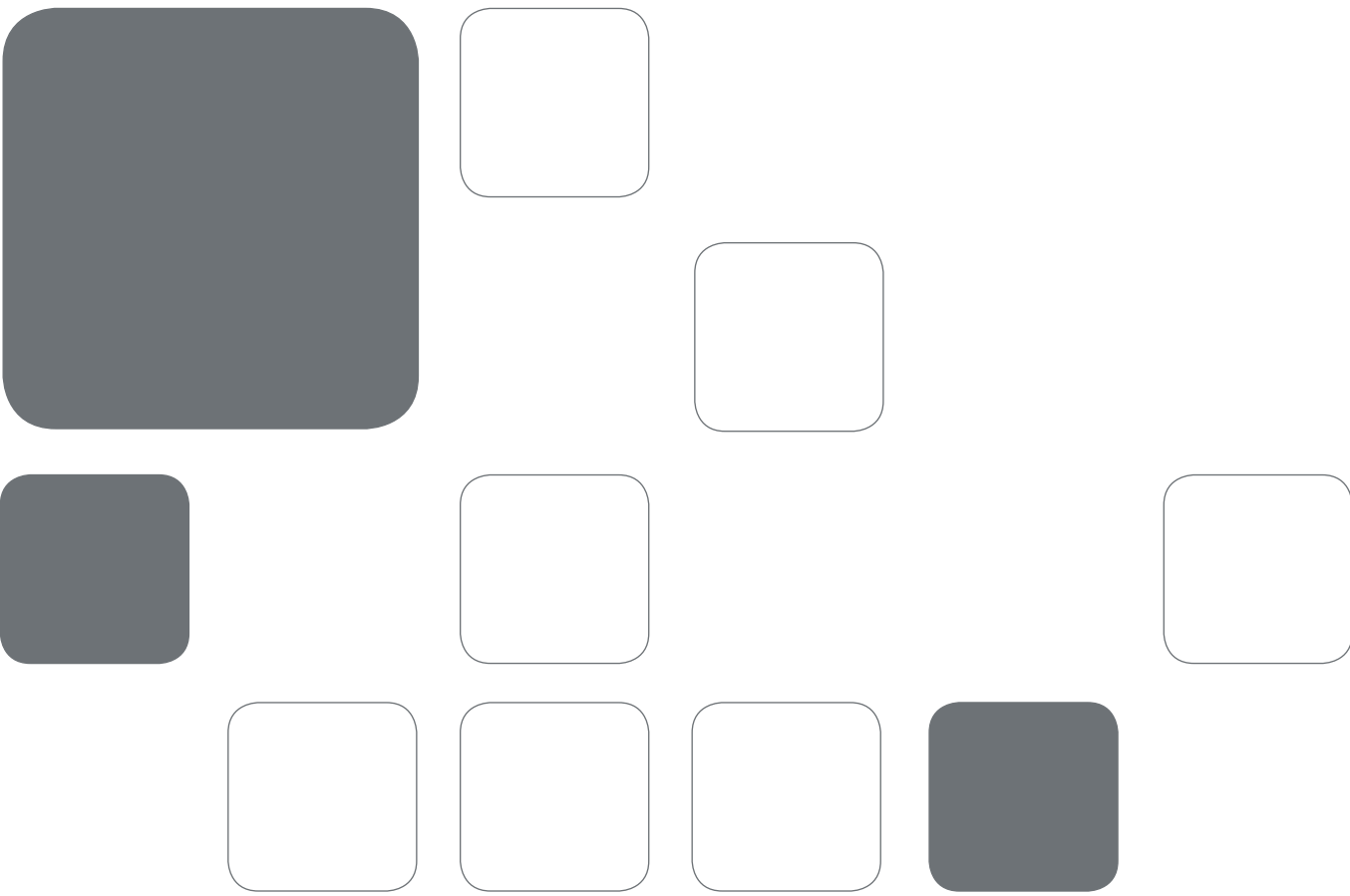

Elenco finiture alluminio disponibili

Aluminium list finishes available

Grezzo - Raw	AL
Anodizzato argento chimico - Chemical silver anodized	ANC
Anodizzato argento brillantato - Glossy silver anodized	ABC
Anodizzato argento spazzolato - Brushed silver anodized	ANS
Anodizzato argento spazzolato brillantato - Brushed glossy silver anodized	ABS
Anodizzato argento lucido - Bright silver anodized	ANL
Anodizzato argento lucidato brillantato - Bright glossy silver anodized	ABL
Anodizzato acciaio spazzolato - Brushed steel anodized	AAS
Anodizzato acciaio spazzolato brillantato - Brushed glossy steel anodized	AASB
Anodizzato champagne spazzolato - Brushed champagne anodized	ACHS
Anodizzato champagne brillantato - Glossy champagne anodized	ACHB
Anodizzato bronzato spazzolato - Brushed bronzed anodized	ABRS
Anodizzato bronzato brillantato - Glossy bronzed anodized	ABRB
Anodizzato tm spazzolato - Brushed dark brown anodized	ATMS
Anodizzato tm brillantato - Glossy dark brown anodized	ATMB
Anodizzato ELOX36 spazzolato - Brushed dark brown ELOX36 anodized	ATM36S
Anodizzato ELOX36 brillantato - Glossy dark brown ELOX36 anodized	ATM36B
Anodizzato nero spazzolato - Brushed black anodized	ANES
Anodizzato nero brillantato - Glossy black anodized	ANEB
Anodizzato titanio spazzolato - Brushed titanium anodized	ATTS
Anodizzato titanio brillantato - Glossy titanium anodized	ATTBC
Anodizzato oro spazzolato - Brushed gold anodized	AOS
Anodizzato oro brillantato - Glossy gold anodized	AOBC
Verniciato alluminio metallizzato - Metalized aluminium painted	AVAM
Verniciato bianco - White painted	AVB
Verniciato marrone scuro - Dark brown painted	AVMSE
Rivestito in carta, PVC e legno - Coated with paper, PVC and wood	



Non utilizzare spray ed oli anti frizione o sblocca filetti sui cuscinetti o sulle ruote con O-ring dei pattini scorrevoli. Questo provoca lo scioglimento dei grassi dei cuscinetti rendendoli rumorosi oppure la rottura dell'O-ring.

Do not use any anti-friction oil or grease or thread-realsee spray on ball bearing or on wheels with O-ring, it can cause the melting of the inside ball bearing grease, making them noisy or causing the break of the O-ring of the wheels.

Tutte le parti del catalogo sono di proprietà della Cinetto Flli S.r.l.

È vietata qualsiasi imitazione e copia delle illustrazioni, della grafica e la riproduzione, anche parziale, del presente catalogo senza autorizzazione.

I disegni tecnici e le informazioni dimensionali, incluse le illustrazioni, riportate in questo catalogo non sono vincolanti. L'azienda si riserva il diritto di apportare modifiche a fini migliorativi. Tutte le dimensioni sono in mm, se non diversamente specificate.

Si declina ogni responsabilità per errori di stampa.

All constituents of the catalogue are the property of Cinetto Flli S.r.l.

Reprint of the catalogue or extracts thereof, reprinting or imitation of the illustrations or imitation of the design is forbidden without permission.

The technical representations and dimensional information in this catalogue are non-binding, including those in the illustrations and drawings. Right reserved to make design improvements. All dimensions are in mm unless otherwise specified.

No liability accepted for printing errors of the catalogue.

Rilasciato da - Issued by
Cinetto Flli S.r.l.

Via Meucci, 4 - 35030 Rubano (PD) Italy

Tel. +39 049 8977211 - Fax +39 049 635822

Internet: www.cinetto.it - Email: info@cinetto.it

June 2018

© by Cinetto Flli S.r.l.

All rights reserved.

Printed in Padova - Italy



**Sede Legale e Officina di
Produzione**

Via Meucci, 4
35030 Rubano (PD) Italy

www.cinetto.it - info@cinetto.it

**Sede Amministrativa,
Magazzino e Punto Vendita**

Via Rossi, 5/A
35030 Rubano (PD) Italy
Tel. +39 049 8977211
Fax +39 049 635822

C.F./P.I. (VAT) (IT) 00277120283

